

5000.1009K1 DATA SHEET

GRATE OPTIONS

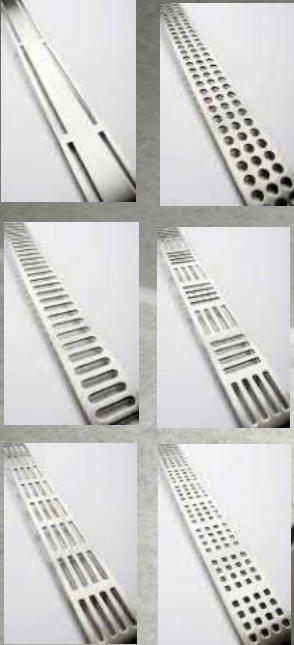

KIT CONTAINS

UNIDRAIN GLASSLINE UNIT WITH
INTEGRATED GLASS CHANNEL
MULTI DIRECTIONAL OUTLET
CLASSICLINE FRAME
ANNIVERSARIO GRATE
GLASS SCREEN

5002.1009 | 5003.1009 Glassline Module

For right-aligned shower screen

For left-aligned shower screen



ITEM NUMBER R

5002.1009

ITEM NUMBER L

5003.1009

Specifications

MATERIAL	SURFACE	FLOORING
1,5 mm stainless steel (AISI 304)	Pickled	Tiles
MEMBRANE	FLOOR CONSTRUCTION	INSTALLATION WIDTH (A)
Liquid or sheet membrane	Concrete/wood	1001 mm
INSTALLATION DEPTH (B)	CENTRE (C)	SHOWER SCREEN SIZE (D)
1001 mm	501 mm	900 mm



1416.0050 - Multi Directional Outlet

Line 1416.0050

Ø 50 mm horizontal drain

Can be rotated 180 degrees if a rear-facing outlet is required.

Note two drains. Cannot be used as an inlet.



Specifications

ITEM NUMBER	GTIN NUMBER	WEIGHT INCLUDING PACKAGING
1416.0050	5707692012520	505 g
WEIGHT EXCLUDING PACKAGING	MATERIAL	USAGE
312 g	Plastic (PP)	Line drain
BARRIER	GASKET	CAPACITY
With	EPDM	0,8 l/s
SIDE INLET	CENTER	FITS DRAIN UNIT
Without	32 mm	1001, 1002, 1003, 1004, 1100, 3002, 3004, 5002, 5003, 4004

FITTING HEIGHTS - LINE FAUCETS 1001, 1002, 1003, 1004

Ø	Outlet direction	300	600	700	800	900	1000	1200
Ø 50 mm	Horizontal	98 mm	102 mm	103 mm	104 mm	105 mm	106 mm	108 mm

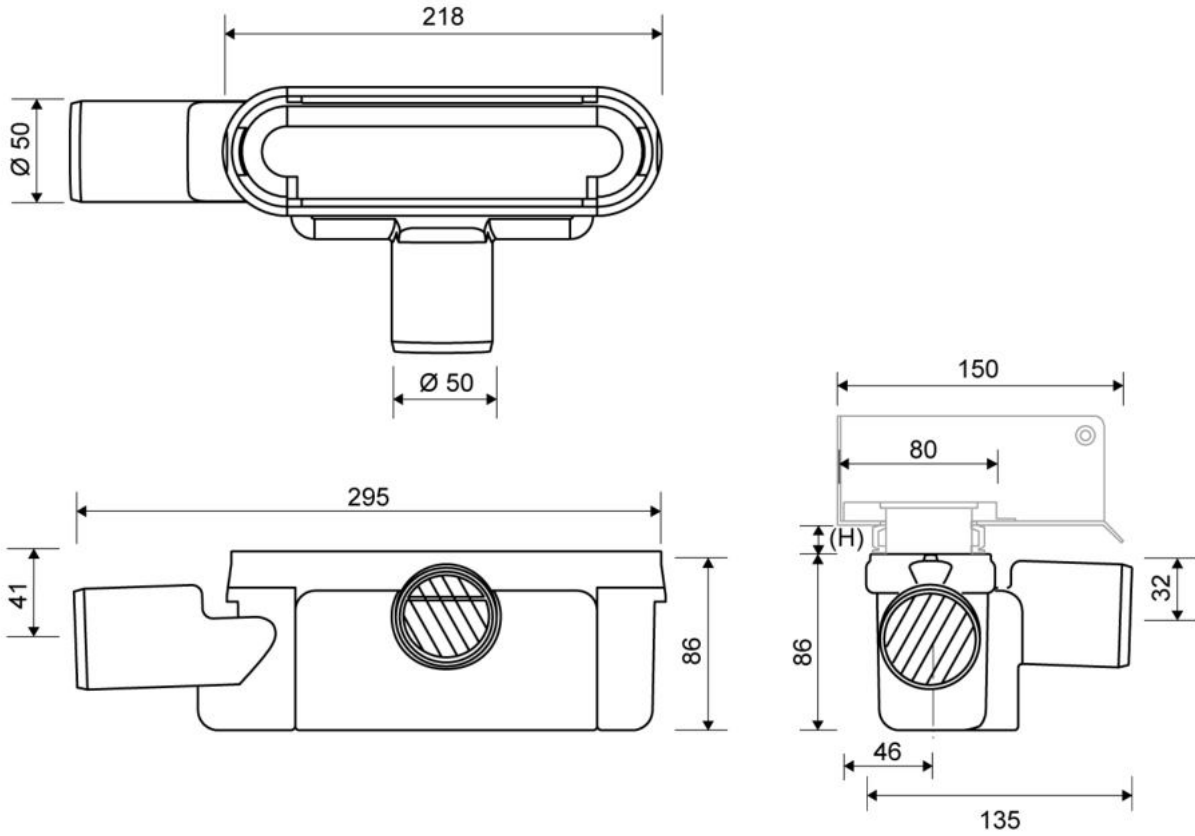

1500.1012

Line 1500

Available in 8, 10 and 12 mm heights (depending on the thickness of the floor tile)



Specifications

ITEM NUMBER	GTIN NUMBER	WEIGHT INCLUDING PACKAGING
1500.1012	5707692003382	1250 g
WEIGHT EXCLUDING PACKAGING	MATERIAL	USAGE
1020 g	Stainless steel (AISI 304)	Line drain
SURFACE	INSTALLATION LENGTH (L)	HEIGHT (H)
Brushed	995 mm	H 12 mm
LENGTH MODEL	FITS DRAIN UNIT	INSERT
1000 mm	1001, 1002, 1003, 1004, 1100, 5002, 5003	Synthetic

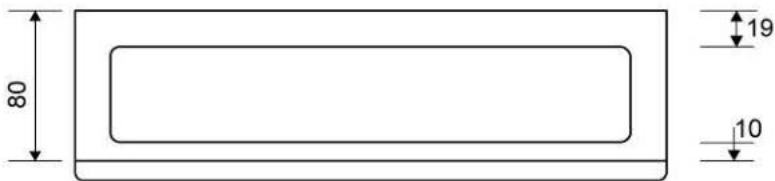
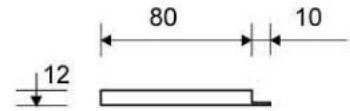
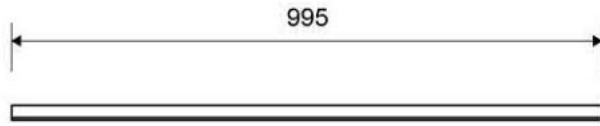

1500.1012

1606.1000 - 1000mm Anniversario Grate

Line 1600

Brushed Stainless Steel grate to be placed onto Classicline Frame

Contact Wet Room Materials for other grate options

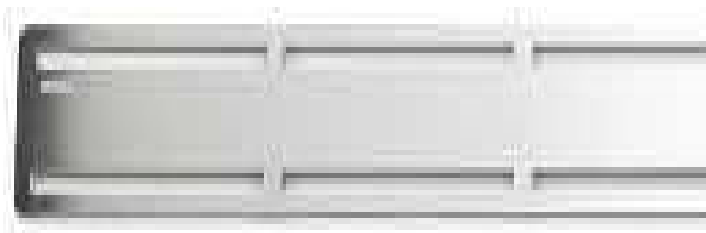

Other grates available

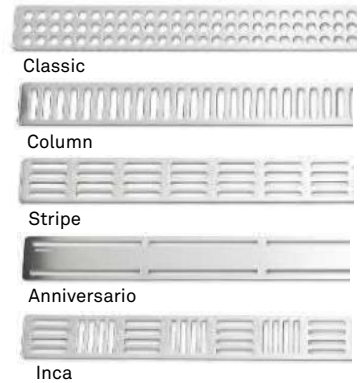

Specifications

ITEM NUMBER	GTIN NUMBER	WEIGHT INCLUDING PACKAGING
1604.1000	5707692001203	940 g
WEIGHT EXCLUDING PACKAGING	MATERIAL	USAGE
910 g	Stainless steel (AISI 304)	Line drain
SURFACE	LENGTH MODEL	DIMENSIONS
Brushed	1000 mm	3 mm solid3 mm solid3 mm solid3 mm solid3 mm solid3 mm solid

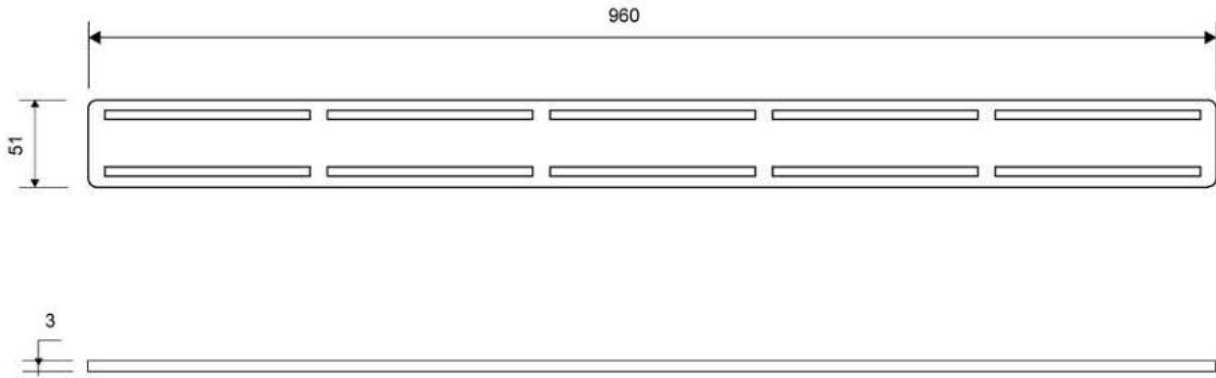

1606.1000

Products

5100.0900

GlassLine | Right and left-aligned shower screen

Design: Transparent

10 mm safety glass

No visible screws or fittings in the finished result

The glass surface is treated with Cleantec nanotechnology, making it water-repellent, less susceptible to limescale and easier to clean.



Specifications

ITEM NUMBER	LENGTH MODEL	HEIGHT (H)
5100.0900	900 mm	2104 mm
DESIGN	MATERIAL	
Transparent	Stainless steel (AISI 304) 10 mm safety float glass	

